

Note: Specifications are subject to change without notice. Always consult factory.

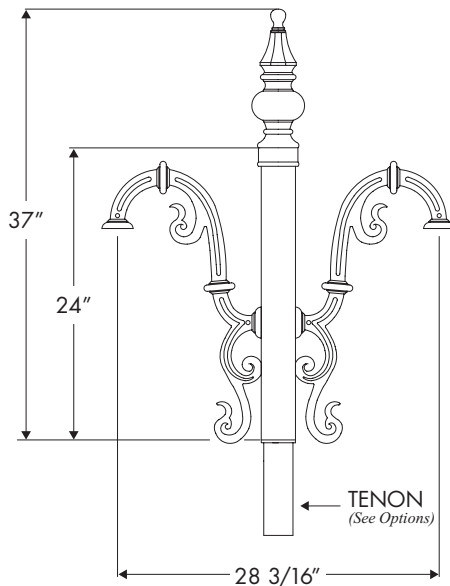

CR-31B

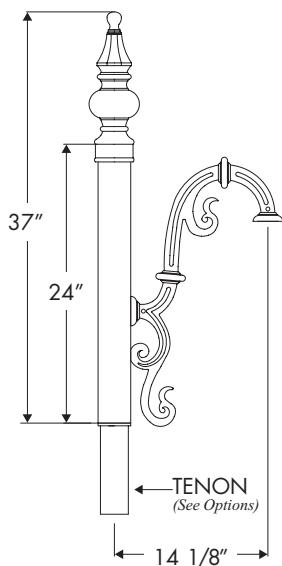

CR-31A

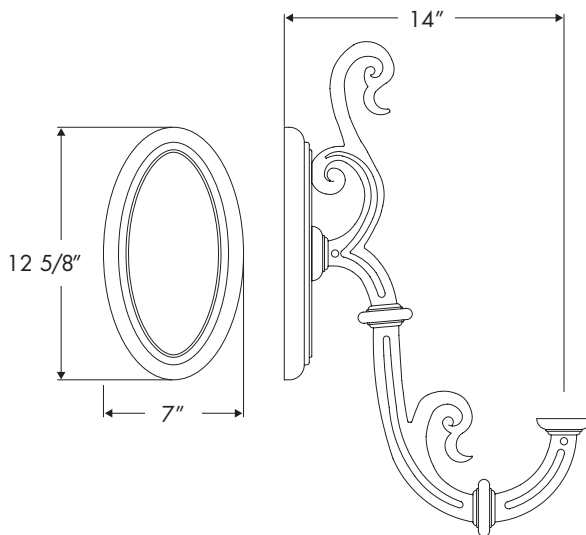

BR-31

Durable Cast and Extruded Aluminum Construction

CONFIGURATIONS



A



B



C1

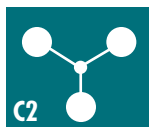

C2



D1



D2



E



Options
 Cross Arm tenon is fitted for 3"
 and 4" diameter poles per request.

Environmental Lighting for Architecture, Inc.
 17891 Arenth Avenue, City of Industry, CA 91748-1197
 626.965.0821 • 800.423.6561 • fax 626.965.9494
 www.ela-lighting.com