

Note: Specifications are subject to change without notice. Always consult factory.

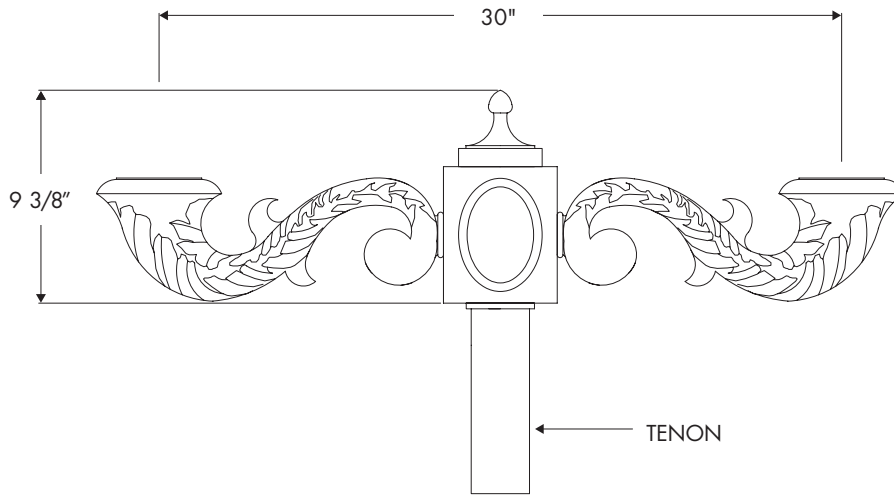

CR-5B

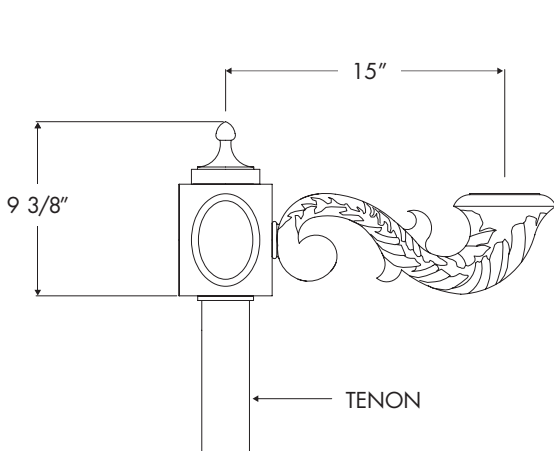

CR-5A

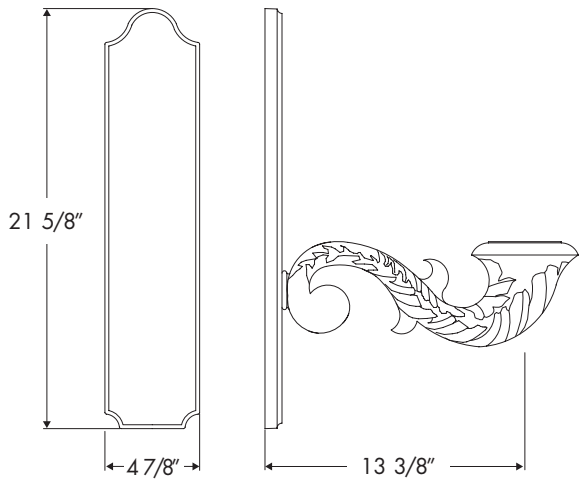

BR-5

Durable Cast and Extruded Aluminum Construction

CONFIGURATIONS



Environmental Lighting for Architecture, Inc.
17891 Arenth Avenue, City of Industry, CA 91748-1197
626.965.0821 • 800.423.6561 • fax 626.965.9494
www.ela-lighting.com