

Project Name:	Type:
Notes:	Order Matrix Number:

BAY 2

Available in four shade sizes, up to 22" diameter, with a clear or frosted jelly jar, the *Bay 2* is an excellent performing outdoor pendant mounted fixture with a nostalgic style. Suitable for cross arm, ceiling (chain or stem) or wall mounting conditions, the *Bay 2* is often specified for restaurants, shopping malls, court houses, museums, historical sites, government buildings, schools and universities, parking lots, site and walkway lighting, lighting for "Old Town" sections of cities, and much more.

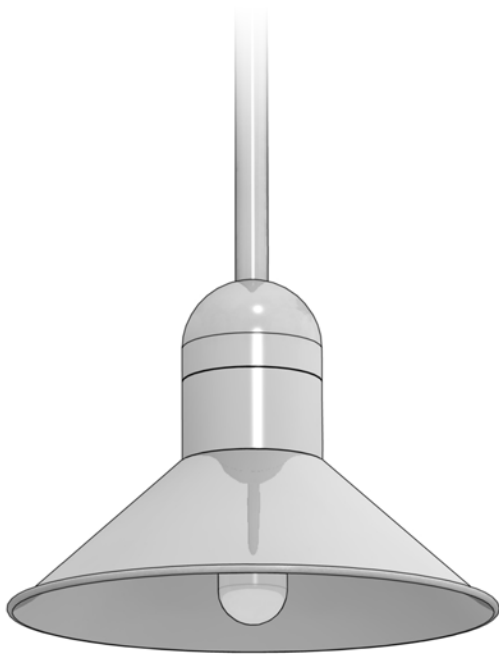

Constructed of high grade cast and spun aluminum and finished with a powder-coated finish, with the inside finished in white to maximize optics, the *Bay 2* is built to endure all outdoor conditions. The *Bay 2* is available in up to a maximum 150 watt Metal Halide or High Pressure Sodium and can also accommodate today's Low-Energy requirements with an assortment of CFL lamps up to 57 watts.

The *Bay 2* has everything you need: Style, durability, and excellent performance to meet many of today's lighting specifications.

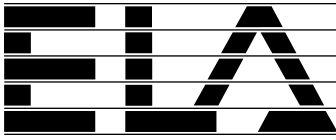

1	2	3	4	5	6	7	8	9
Fixture /	Size /	Mounting /	Optics /	Ballast /	Voltage /	Lens /	Color /	Option
BY2 /	18 /	CA /	V5 /	100PSMH /	120 /	FG /	CY /	--

1. Fixture: BY2

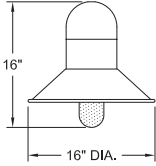
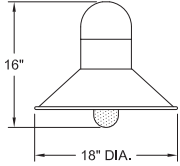
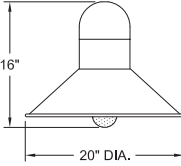
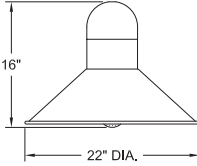

2. Size

			
Matrix #: 16	Matrix #: 18	Matrix #: 20	Matrix #: 22
Description:	Description:	Description:	Description:
Notes: Max Wattage 150W	Notes: Max Wattage 150W	Notes: Max Wattage 150W	Notes: Max Wattage 150W
EPA: 0.7	EPA: 0.8	EPA: 0.9	EPA: 1.0
Weight: 21 lbs.	Weight: 22 lbs.	Weight: 23 lbs.	Weight: 24 lbs.

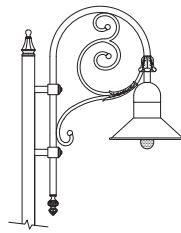
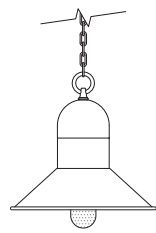
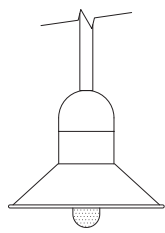
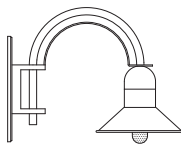
3. Mounting

			
Matrix #: CA	Matrix #: CP	Matrix #: SP	Matrix #: WB
Description: Cross Arm	Description: Chain Pendant	Description: Stem Pendant	Description: Wall Bracket

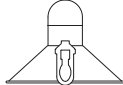
4. Optics









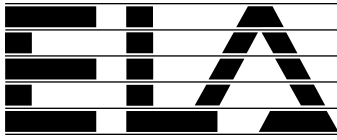

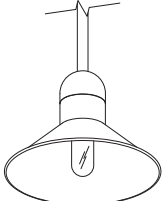
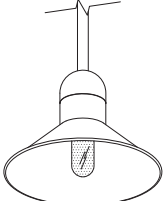
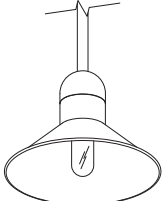
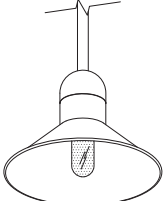
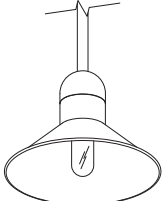
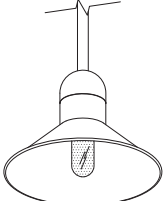

<p>Vertical</p> 	
Matrix #:	Matrix #:
Description:	Description:

5. Ballast

Description:	Pulse Start Metal Halide (Watts / Type)	Metal Halide (Watts / Type)	High Pressure Sodium (Watts / Type)	Compact Fluorescent (Watts / Type)	Incandescent (Watts / Type)
Matrix #:	50PSMH	70MH	70MH	50HPS	13CFL
	70PSMH	T6 70MH	70HPS	70HPS	18CFL
	100PSMH	100MH	100HPS	100HPS	26CFL
	150PSMH	T6 150MH	150HPS	150HPS	32CFL
		150MH			42CFL
					57CFL

Notes:
 1. Electronic ballast available for 50, 70, and 100 watt MH lamps.
 2. Other wattages available. Consult factory.



6. Voltage	<table border="0"> <tr> <td>Matrix #:</td> <td>120</td> <td>208</td> <td>240</td> <td>277</td> <td>347</td> <td>480</td> </tr> <tr> <td>Description:</td> <td>120V</td> <td>208V</td> <td>240V</td> <td>277V</td> <td>347V</td> <td>480V</td> </tr> </table>						Matrix #:	120	208	240	277	347	480	Description:	120V	208V	240V	277V	347V	480V																														
Matrix #:	120	208	240	277	347	480																																												
Description:	120V	208V	240V	277V	347V	480V																																												
7. Lens Notes: Consult factory for custom lens options.	<table border="0"> <tr> <td style="text-align: center;">  CG Clear Glass </td> <td style="text-align: center;">  FG Frosted Glass </td> </tr> </table>						 CG Clear Glass	 FG Frosted Glass																																										
 CG Clear Glass	 FG Frosted Glass																																																	
8. Color Notes: Consult factory for custom colors.	Powder Coat Finish <table border="0"> <tr> <td>Matrix #</td> <td>Description</td> <td>Matrix #</td> <td>Description</td> </tr> <tr> <td>AG</td> <td>Augustine Green</td> <td>MG</td> <td>Malaga Green</td> </tr> <tr> <td>GY</td> <td>Architectural Grey</td> <td>MN</td> <td>Midnight</td> </tr> <tr> <td>CC</td> <td>Charcoal</td> <td>PW</td> <td>Pewter</td> </tr> <tr> <td>CY</td> <td>Clay</td> <td>SS</td> <td>Sand Storm</td> </tr> <tr> <td>DB</td> <td>Dark Bronze</td> <td>SB</td> <td>Statuary Bronze</td> </tr> <tr> <td>HR</td> <td>Harbor Blue</td> <td>VL</td> <td>Village Green</td> </tr> <tr> <td>HP</td> <td>Hammered Pewter</td> <td>W</td> <td>White</td> </tr> </table>			Matrix #	Description	Matrix #	Description	AG	Augustine Green	MG	Malaga Green	GY	Architectural Grey	MN	Midnight	CC	Charcoal	PW	Pewter	CY	Clay	SS	Sand Storm	DB	Dark Bronze	SB	Statuary Bronze	HR	Harbor Blue	VL	Village Green	HP	Hammered Pewter	W	White	Hand-Applied Finish <table border="0"> <tr> <td>Matrix #</td> <td>Description</td> </tr> <tr> <td>CH</td> <td>Cracked Hide</td> </tr> <tr> <td>LV</td> <td>Light Verde</td> </tr> <tr> <td>OR</td> <td>Old Iron</td> </tr> <tr> <td>R</td> <td>Rust</td> </tr> <tr> <td>V</td> <td>Verde</td> </tr> </table>			Matrix #	Description	CH	Cracked Hide	LV	Light Verde	OR	Old Iron	R	Rust	V	Verde
Matrix #	Description	Matrix #	Description																																															
AG	Augustine Green	MG	Malaga Green																																															
GY	Architectural Grey	MN	Midnight																																															
CC	Charcoal	PW	Pewter																																															
CY	Clay	SS	Sand Storm																																															
DB	Dark Bronze	SB	Statuary Bronze																																															
HR	Harbor Blue	VL	Village Green																																															
HP	Hammered Pewter	W	White																																															
Matrix #	Description																																																	
CH	Cracked Hide																																																	
LV	Light Verde																																																	
OR	Old Iron																																																	
R	Rust																																																	
V	Verde																																																	
9. Options Notes: 1. BBU option is available for fluorescent lamp only. 2. Test button location shall have visibility for testing on site. Consult factory for placement location. Photocell Options: Photocell is available in 120 thru 480 volts. Specify when ordering.	<table border="0"> <tr> <td style="text-align: center;">  BBU Battery Backup </td> <td style="text-align: center;">  TB Terminal Block </td> <td style="text-align: center;">  PCB Photocell Button </td> <td style="text-align: center;">  HSS House Side Shield </td> </tr> </table>						 BBU Battery Backup	 TB Terminal Block	 PCB Photocell Button	 HSS House Side Shield																																								
 BBU Battery Backup	 TB Terminal Block	 PCB Photocell Button	 HSS House Side Shield																																															

Fixture Ordering Example:

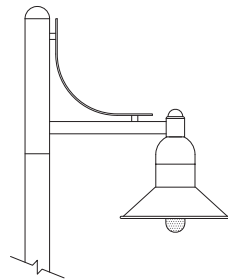

BY2/18/CA/V5/100PSMH/120/FG/CY

1	2	3	4	5	6	7	8	9
Fixture	Size	Mounting	Optics	Ballast	Voltage	Lens	Color	Option
BY2	18	CA	V5	100PSMH	120	FG	CY	-
Bay 2 Fixture	18	Cross Arm	Vertical Type 5	100 Watt Pulse Start Metal Halide	120 Volts	Frosted Glass	Clay	-

Fixture Ordering Form:

1	2	3	4	5	6	7	8	9	9	9
Fixture	Size	Mounting	Optics	Lamp	Voltage	Lens	Color	Option	Option	Option

1. BY2 / _____ / _____ / _____ / _____ / _____ / _____ / _____ / _____ / _____ / _____

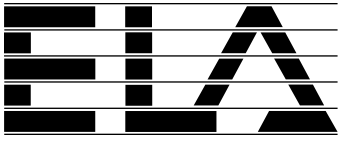

Specifications

Fixture Housing: One-piece sand-cast ballast housing with a spun aluminum shade. Housing shall be corrosion resistant cast aluminum alloy #A356. The housing shall be free of any foreign materials or cosmetic fillers.

Optics: The lamp shall be an open, type 5 output. Also available with house side shield option that is fully rotatable on site.

Electrical Module: All electrical components are UL and CSA recognized, mounted on a single plate, and factory prewired. An optional quick-disconnect plug for the ballast module is standard. *Reference pages 2 and 3 for lamp characteristics, ballast types, and voltage technical data.*

Lens: The glass lens shall be a borosilicate glass, jelly jar style, vapor jar. Removable for re-lamping. Available in a clear or frosted finish.

Finish/Color: Finish is super TGIC thermoset polyester powder coat paint. ELA offers RAL color matches along with our standard color selection. Custom and hand applied colors are available upon special request.

Certification: Fixtures shall be listed for outdoor, wet location. UL1598. IP rating 44.

CAUTION: Fixtures must be grounded in accordance with national, state, and/or local codes. Failure to do so may result in serious personal injury.

ELA RESERVES THE RIGHT TO CHANGE SPECIFICATIONS WITHOUT NOTICE.

Elevated Scale

Suggested Poles and Arms
for the Bay 2 Fixture

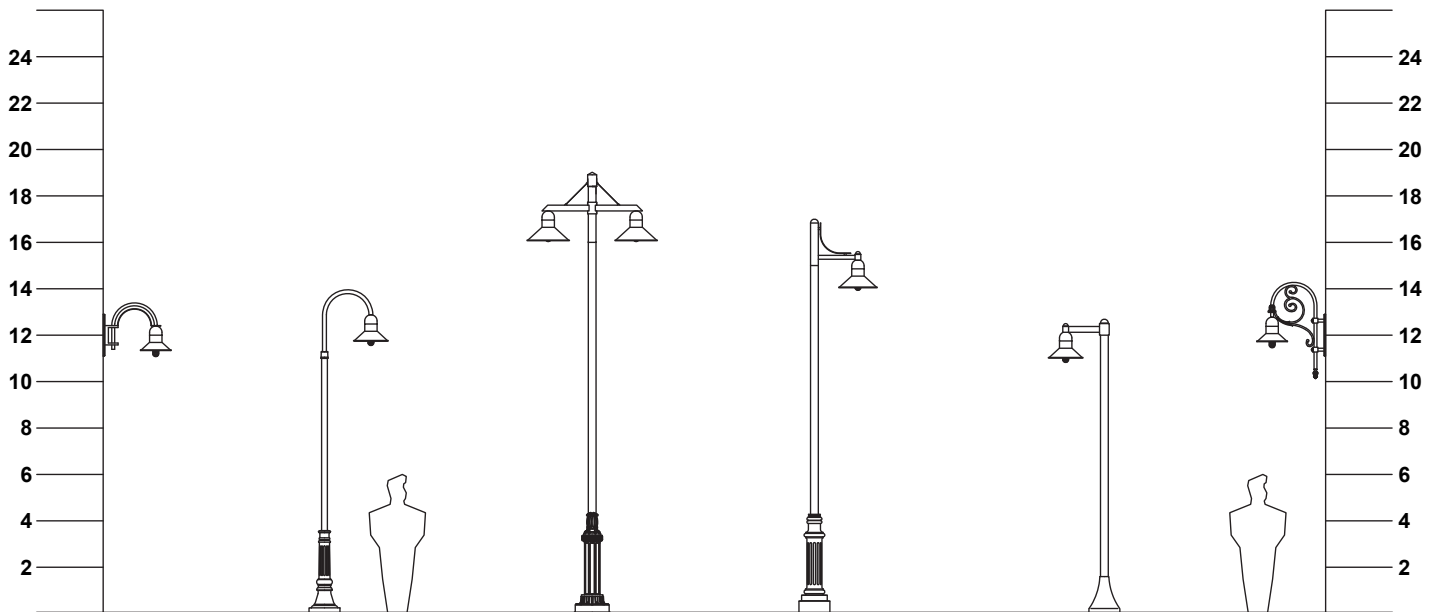

Fixture :	BY2/16/WB	BY2/18/CA	BY2/22/CA	BY2/20/CA	BY2/18/CA	BY2/16/WB
Arm :	WB14	CA17A	CA21B	CA111A	CA112A	WB16
Pole:		P3016A-12'	P3025D-16'	P3042B-14'	P4014B-12'	
Options :						

Note: Modifications to the fixture and additional pole heights are available.