

Note: Specifications are subject to change without notice. Always consult factory.

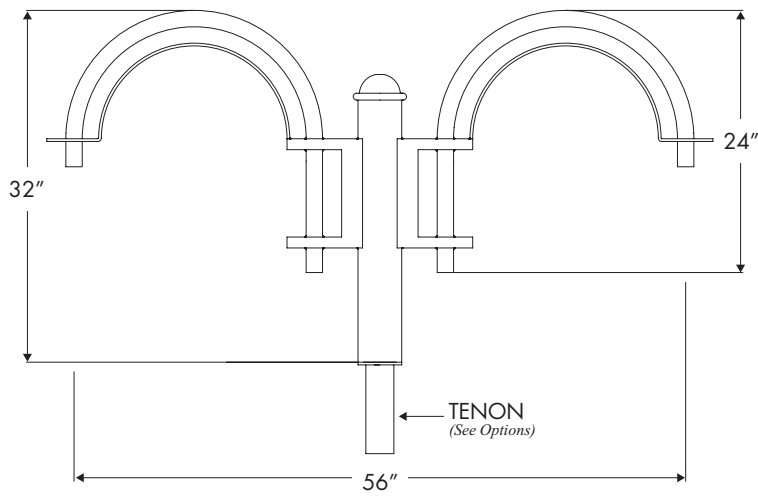

CR-14B

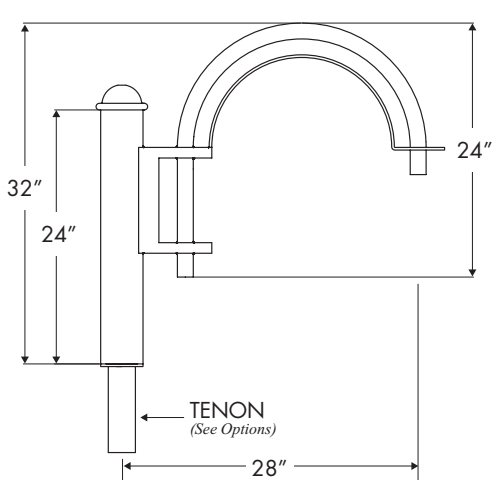

CR-14A

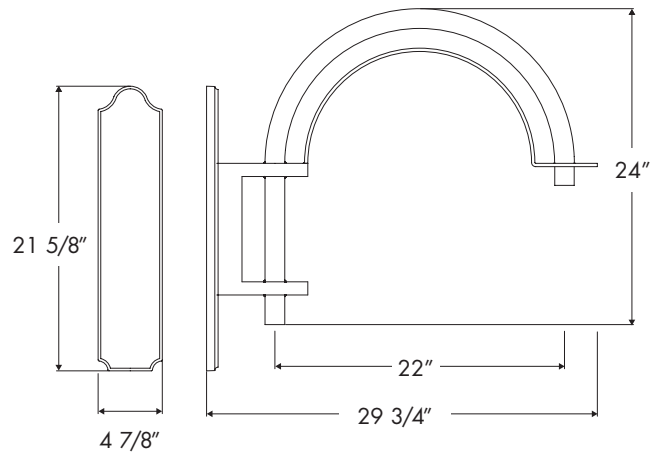

BR-14

Durable Cast and Extruded Aluminum Construction

CONFIGURATIONS

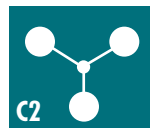

Options
Cross Arm tenon is fitted for 3"
and 4" diameter poles per request.

Environmental Lighting for Architecture, Inc.
17891 Arenth Avenue, City of Industry, CA 91748-1197
626.965.0821 • 800.423.6561 • fax 626.965.9494
www.ela-lighting.com