

Note: Specifications are subject to change without notice. Always consult factory.

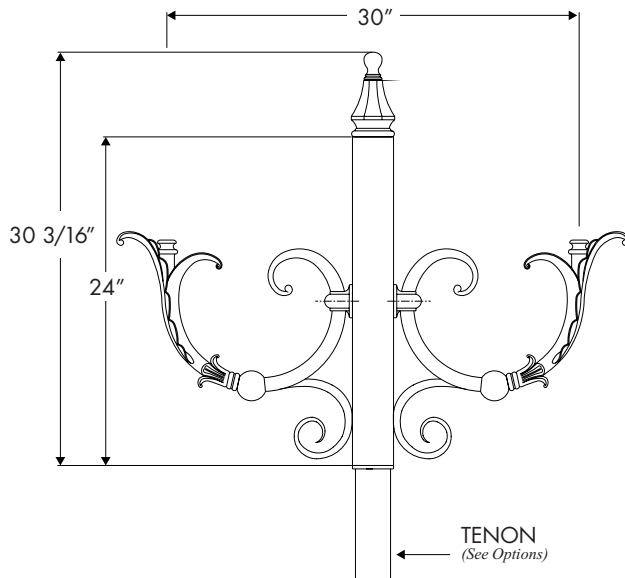

**CR-333B**

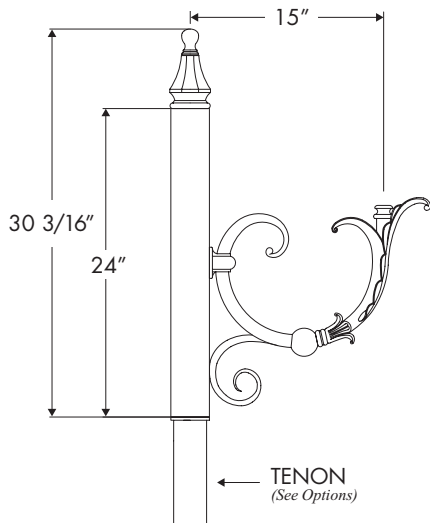

**CR-333A**

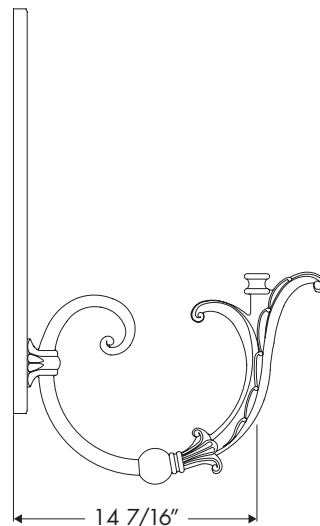

**BR-333**

*Durable Cast and Extruded Aluminum Construction*

**CONFIGURATIONS**

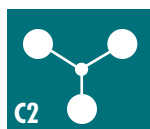
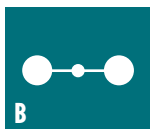

*Options*  
Cross Arm tenon is fitted for 3"  
and 4" diameter poles per request.

**Environmental Lighting for Architecture, Inc.**  
17891 Arenth Avenue, City of Industry, CA 91748-1197  
626.965.0821 • 800.423.6561 • fax 626.965.9494  
www.ela-lighting.com