

Note: Specifications are subject to change without notice. Always consult factory.

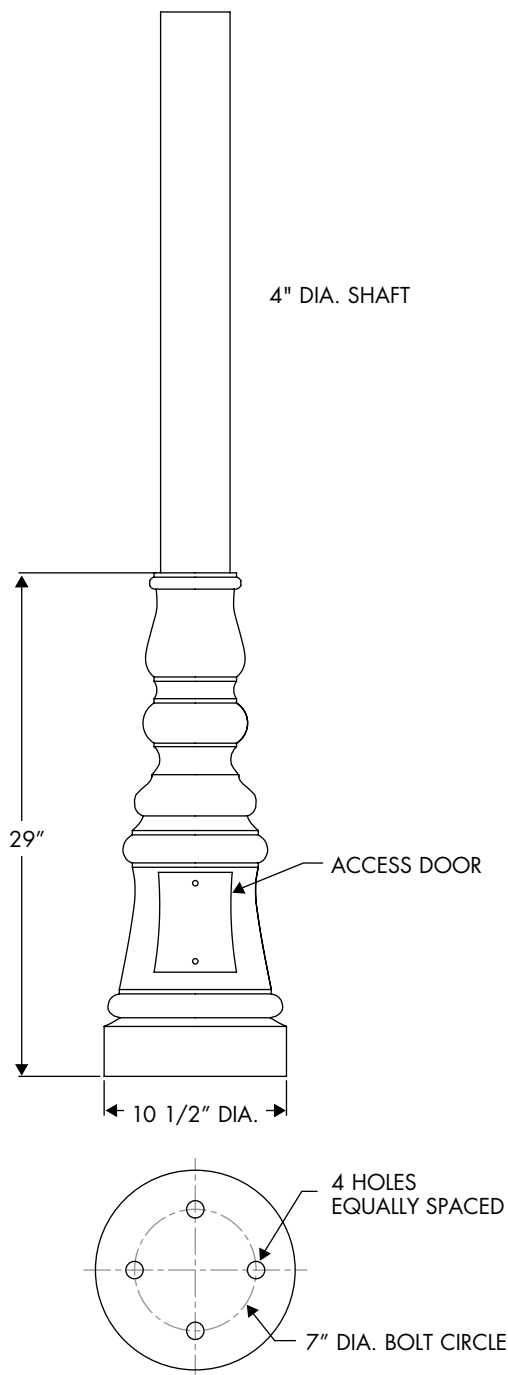

P-3039 BASE

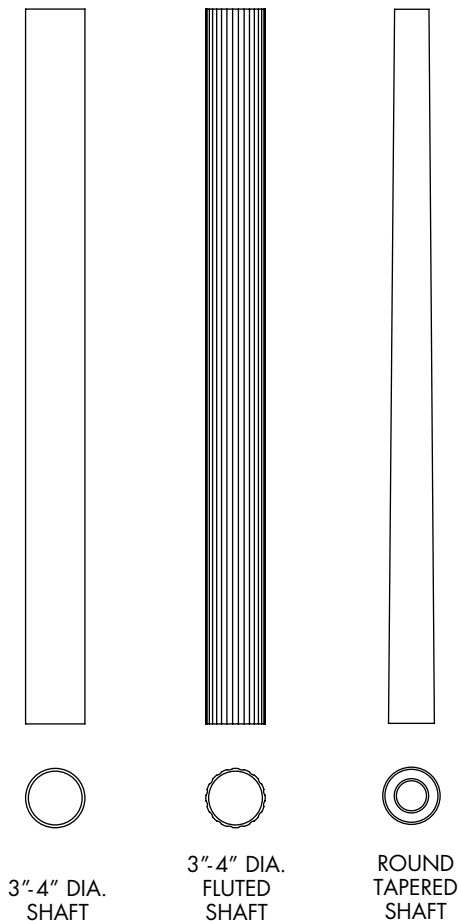

Alternate Pole Shafts

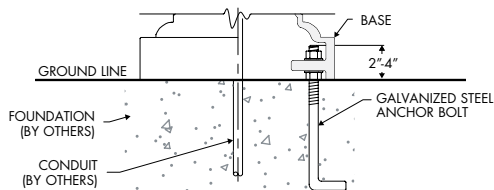

Mounting Bolt Conditions with a Pole Base (Basic Example)

Maximum Pole Heights and Shaft types differ per project.

Pole shafts are normally determined by material loading specifications, location of project, and EPA requirements.

Please contact factory.

