

Note: Specifications are subject to change without notice. Always consult factory.

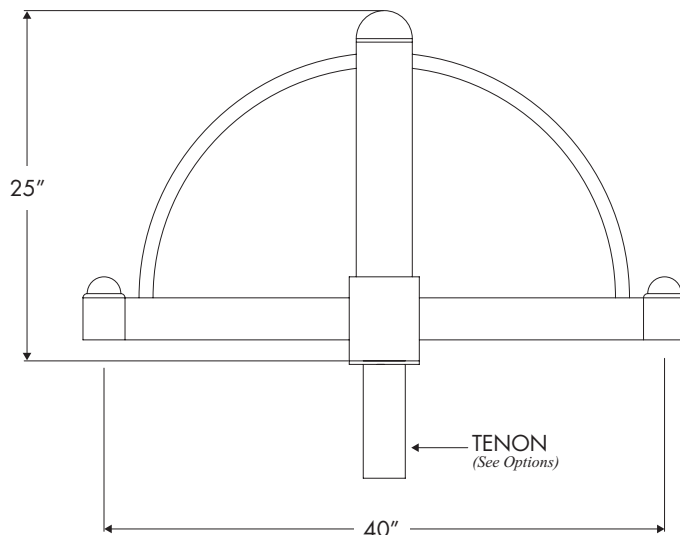

CR-40B

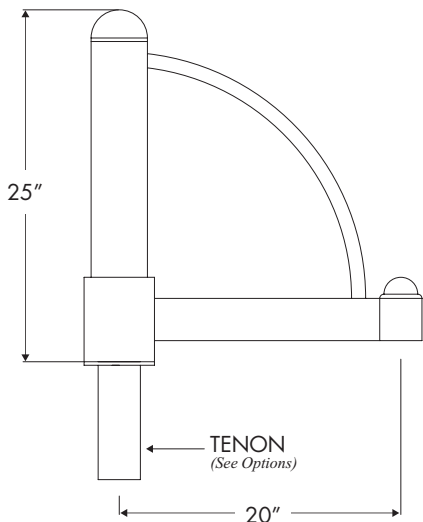

CR-40A

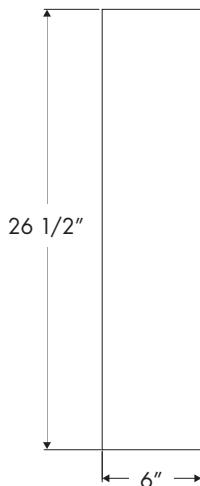

BR-40

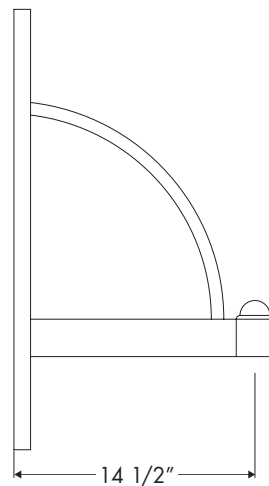

Durable Cast and Extruded Aluminum Construction

CONFIGURATIONS

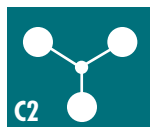
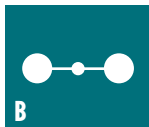

Options
 Cross Arm tenon is fitted for 3" and 4" diameter poles per request.

Environmental Lighting for Architecture, Inc.
 17891 Arenth Avenue, City of Industry, CA 91748-1197
 626.965.0821 • 800.423.6561 • fax 626.965.9494
 www.ela-lighting.com