

Note: Specifications are subject to change without notice. Always consult factory.

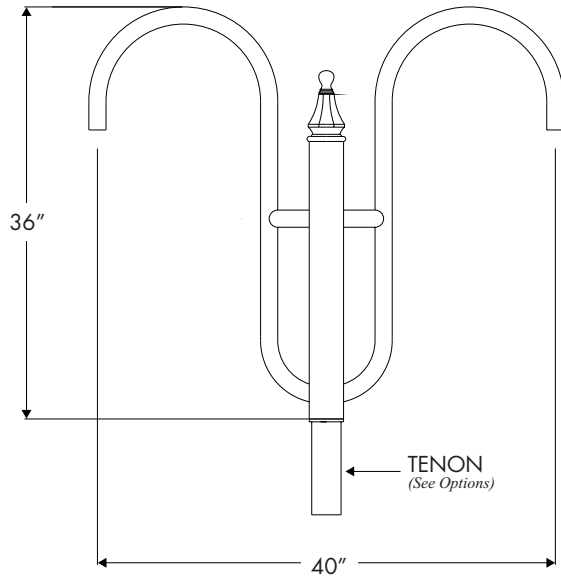

CR-19B

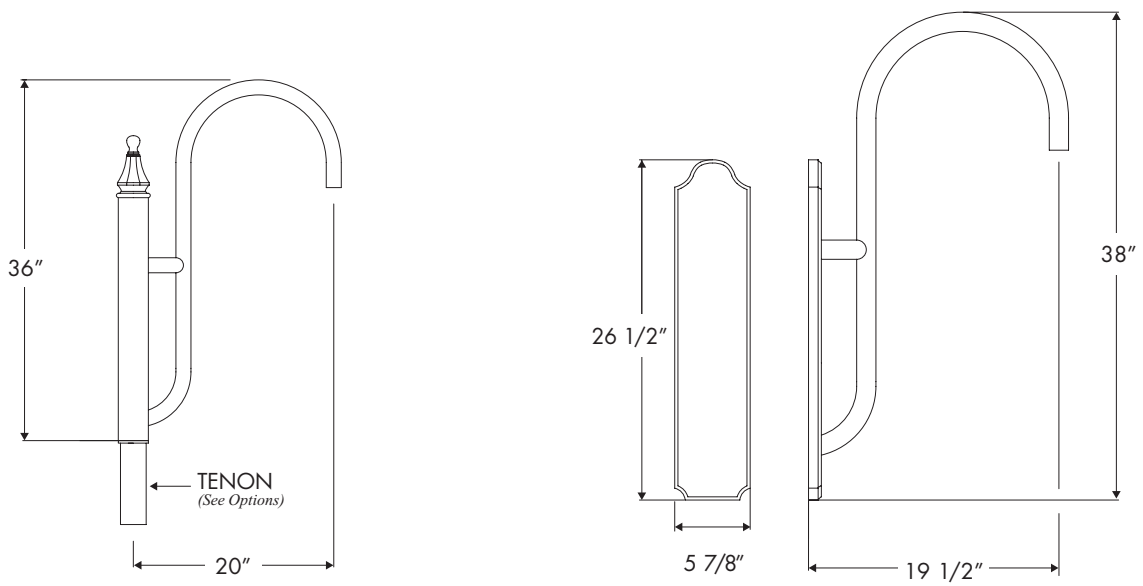

CR-19A

BR-19

Durable Cast and Extruded Aluminum Construction

CONFIGURATIONS

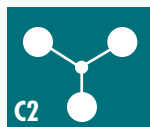

Options

Cross Arm tenon is fitted for 3" and 4" diameter poles per request.

Environmental Lighting for Architecture, Inc.
 17891 Arenth Avenue, City of Industry, CA 91748-1197
 626.965.0821 • 800.423.6561 • fax 626.965.9494
 www.ela-lighting.com